

PROCEEDINGS OF THE RADIO CLUB OF AMERICA

Volume 16

JULY, 1939

No. 2

FREQUENCY MODULATION IN RADIO BROADCASTING

(A report of the meeting of the Radio Club of America

March 23, 1939)

The regular monthly meeting of The Radio Club on Mar. 23, 1939 was devoted to a series of presentations, demonstrations, and discussion of frequency modulation as applied to radio broadcasting. In view of the fact that what was probably the first public discussion of the subject was had before a meeting of the Club some fifteen years ago, and in view also of the fact that Professor Armstrong's first public disclosure of the details and the characteristics of his wide band system of frequency modulation was presented before the Club some three years ago, it was especially fitting that the series of presentations indicating the progress in this new art as here reported should be made before the Club.

Those who heard Professor Armstrong's epoch-making presentation on the subject on Dec. 19, 1935, will remember how startlingly that presentation called the attention of engineers and experimenters to the generally unappreciated possibilities resident in frequency modulated waves for the purposes of radio transmission where high fidelity is of importance. Since the time of that memorable presentation much intensive work, both analytical and experimental, has been carried on by Prof. Armstrong himself and his immediate associates, and by other interested groups, as well. The presentations at the March meeting were therefore, by way of a progress report in that not only did they report the several directions of development of f.m.w. broadcasting but they brought out the vast progress that has been made in this field in the few years since Prof. Armstrong's first presentation.

Prof. Armstrong's early experiments and analyses and the analyses of Hans Roder, of Harold Wheeler and of others called attention to the capacity of f.m.w. systems for the avoidance of interference from noise and other radio interference sources. These have now been supplemented by the work of the General Electric group at Schenectady—as reported by Mr. Weir—in the extensive, quantitative determinations of the extent to which these advantages can be realized under practical operating conditions.

In view of the rapidly developing tendency toward the adoption of f.m.w. systems for the extension of sound broadcasting within the United States to frequencies above 30 megacycles, there has been a distinct need for the investigation and discussion of the problems to be faced in the design of u.h.f., f.m.w. receivers suitable for large-scale production and for use in the hands of the listening public. This need has been met in the presentation by Mr. C. W. Fyler describing the f.m.w. receivers developed by the General Electric group at Bridgeport.

Supplementing these reports, demonstrations were provided by Professor Armstrong through his 20 K.W. f.m.w. transmitter at Alpine, N. J. and through the amateur station W2AG of Mr. Runyon at Yonkers, N. Y. In addition, reports were had from Mr. Doolittle and Professor Noble concerning their experiences with frequency modulation in the Connecticut area and their plans for the development of u.h.f., f.m.w. broadcasting in that area. Reports were had as well from Mr. Paul De Mars of the Yankee network of the rapid progress which his group is making in the development of additional broadcasting facilities through the use of frequency modulation in the u.h.f. bands. In addition to which the informal discussion which followed these presentations and demonstrations did much to acquaint those who attended the meeting with the details of the work that is being done in this increasingly important field.

In reviewing this report of the several presentations at the March 23, 1939 meeting, certain of the material of Professor Armstrong's earlier presentation should be kept in mind, amongst this, the essential characteristics of frequency modulation as a means of imposing program content on a radio carrier as contrasted with the analogous process in the case of amplitude modulation should be borne in mind. Thus, the latter process is designed to vary the amplitude of the radio signal in accordance with the program content both as to audio frequency and amplitude, while maintaining the frequency of the radio signal constant and independent of the modulation except, perhaps, as the process may be viewed as resulting in the generation of side frequencies. Conversely, the process of frequency modulation is designed to vary the frequency of the radio signal in accordance both with the amplitude and the frequency of the program material to be transmitted while maintaining the amplitude—and hence the power—of the radio signal constant and independent of the modulation.

Just as in the case of amplitude modulation, there are probably many detailed methods that may be followed in imposing the program content on the carrier wave by modulation of its frequency. Typical of this wide range of practical possibilities are the several methods already proposed. Thus, in Professor Armstrong's earlier paper he pointed out the method whereby an amplitude modulated wave might—and, indeed, is in Professor Armstrong's station—converted into a wide band frequency modulated wave. In brief, this comprises the segregation of the side bands from the carrier, the rotation of the side band vector by ninety degrees, the re-addition of the carrier to the side bands, and the frequency multiplication of the carrier-side band combination to whatever degree of

frequency swing or deviation is found desirable. Then, too, as suggested by Mr. Murray G. Crosby and as incorporated in the transmitters used in the investigations reported by Mr. Weir, the simple and direct modulation of the frequency of the carrier may be accomplished by causing a reactive element in the frequency determining circuit of the transmitter to be appropriately varied in accordance with the program material to be transmitted.

Whatever the detailed method the objective is that of causing the frequency of the radio signal to vary about the value which it has in the absence of modulation in accordance with the amplitude and the frequency of the program material.

In the practice of either of these types of modulation freedom from the other type of modulation is probably never completely realized in that there are usually vestiges of frequency modulation to be found in conventional transmitters employing amplitude modulation, while there are doubtless traces of amplitude modulation to be found in practical transmitters employing frequency modulation. In general, however, broadcast receivers to operate on amplitude modulated signals are commonly so designed as to be free of the effects of vestigial frequency modulation, while Professor Armstrong's system employs in the receiver a current or voltage limiting element—commonly called a "limiter"—which frees the output of the

receiving system of the influence of even great ranges of amplitude modulation from whatever sources.

Additionally, the f.m.w. receiver distinguishes itself from its much older brother, the a.m.w. receiver, not only in the great width and nature of its acceptance band but in the inclusion of a "detector" or demodulator through the functioning of which the f.m.w. signal is converted into an audio signal faithfully reproducing the program content of the RF signal.

The net result of the characteristics of the transmission and of the equipment is to provide a high degree of avoidance of noise or radio signal interference, for reasons that are detailed in the analysis referred to above and in the references below or, as suggested most succinctly by Professor Armstrong long since, because the commoner forms of noise and other interferences are largely characterized by amplitude modulation to which the frequency modulation system is deaf.

To the question of the extent to which these desirable characteristics are present in a practical f.m.w. broadcasting system as contrasted with a practical a.m.w. broadcasting system, Mr. Weir's presentation provided a direct and intensely important answer. And to the question as to what must be done to adapt conventional, u.h.f. broadcast receiver design practises to the needs of this new system, Mr. Fyler's presentation gave an equally interesting and important answer. The editors have, therefore prepared the following review of these presentations.

COMPARATIVE FIELD TESTS OF FREQUENCY MODULATION AND AMPLITUDE MODULATION TRANSMITTERS

Irwin R. Weir*

SUMMARY: The equipment, procedure, and results, of field tests are described in which a series of comparisons were made between broadcasting systems operating at approximately 41 megacycles using, respectively, frequency and amplitude modulation. Suitable transmitters were installed at Schenectady and at Albany, and observations were made thru out the region between these cities with a portable receiver carried in an automobile.

At Schenectady separate transmitters for frequency modulation and for amplitude modulation were provided, each delivering 50 watts carrier output. A block circuit diagram of the f.m.w. transmitter is given in Figure 1, the general type being that suggested by Murray G. Crosby. This comprises an oscillator and frequency modulator in which a re-

active element is suitably varied by the output of the speech amplifier, a frequency doubler and a power amplifier. The remainder of the equipment provides for the automatic compensation of the oscillator against changes in its frequency. In the absence of modulation the transmitted frequency is held accurately at 41 megacycles by the 13.166 megacycle crystal oscillator. The output of the crystal oscillator is "tripled" to 39.5 megacycles, which on heterodyning with the 41-megacycle transmitted frequency, produces an "intermediate frequency" of 1.5 megacycles which is detected and acts upon the frequency modulator. The circuit of the frequency modulator is of the type commonly used for frequency control in receivers having a.f.c. In this case it provides for the control of the frequency of the 20.5-megacycle vacuum tube oscillator. In this way any departure of the 20.5-megacycle oscillator from the desired frequency reflects itself in a reaction by the frequency control circuit and it is thereby, kept accurately on frequency. As shown in the diagram, the output of this oscillator is doubled in frequency to obtain the output frequency of the station. The circuit constants of the automatic frequency control circuit are such as to limit its action to slow changes in frequency so that its operation is independent of even the lowest audio frequencies that may be delivered by the speech amplifier. When the program modulation is applied by the speech amplifier, the frequency modulator varies the frequency of the 20.5-megacycle oscillator in accordance with the audio wave, and the desired frequency modulation is thus obtained.

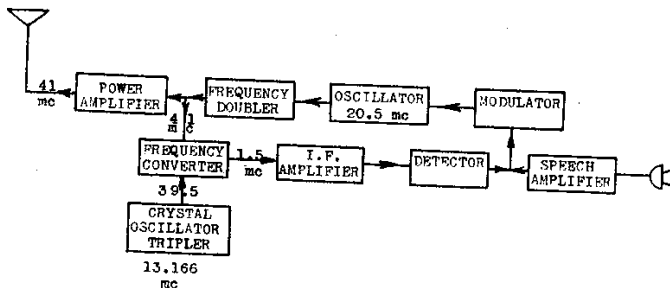

Fig. 1—Frequency Modulated Transmitter Used at Schenectady.

(* General Electric Co., Schenectady, N. Y.

Tube Complement	
Power Amplifier	2
Frequency Doubler	1
20.5 mc Oscillator	1
Modulator	1
Crystal Multiplier	1
Frequency Converter	1
Detector	1
Speech Amplifier	1
I. F. Amplifier	1
Crystal Oscillator Tripler	1

From an equipment standpoint a general comparison of the two Schenectady transmitters is to be noted from Figure 2. The f.m.w. transmitter is shown at the left and the a.m.w. transmitter at the right. The total input power taken by each transmitter when unmodulated is there shown. It should be borne in mind that as contrasted with the amplitude modulated transmitter in which a peak power of four times the rated power must be provided for, both in power supply and tube complement, in the frequency-modulated transmitter there is no change of power upon modulation with the resultant economy of power and equipment.

At Albany a single 150-watt convertible transmitter was used. When connected for frequency modulation this included equipment essentially identical to the 50 watt Schenectady frequency-modulation transmitter the output of which was arranged to drive a two-stage power amplifier. The first of these, or intermediate power amplifier, consisted of two Type 800 tubes, and the final stage consisted of four additional Type 800 tubes with a plate voltage of 1000 volts on the final stage. Thru the use of suitable switching and modulation equipment, the conversion to amplitude modulation was readily possible employing the same output stage, feed line, antenna, etc.

At both transmitter locations vertical J-type antennas were used. At Schenectady the antenna, located on a mast on Building 40 of the General Electric Works was about 240 feet above the ground level. At Albany the antenna was located about 390 feet above the ground, atop the New York State Office Building. The relative levels of these two locations and approximate topography of the intervening terrain are suggested by Figure 6.

The portable receiver which was used in the measurements consisted of a convertible, triple-detection type. All circuit elements for reception of either type of modulation were identical except as in the f.m.w. observations the limiter and the f.m.w. detector or demodulator replaced the conventional detector. The receiver included one stage of radio-frequency amplification, tunable in a narrow range about 41 megacycles and using a ZP-332 tube. The first converter included a 6C5 as oscillator and a 6L7 as modulator, producing the first intermediate frequency of 6.6 megacycles. The first intermediate amplifier, operating at this frequency comprised one stage using a ZP-332 tube. The second converter employed a 6A8 as crystal-controlled oscillator and modulator. The second intermediate amplifier, operating at 0.8 megacycle, used two ZP-333 tubes. The limiter circuit employed a 6J7 as the current limiting element and a 6F6 in a selective amplifier. The f.m.w. demodulator circuit included a 6H6. The audio amplifier employed a 6J7 in the first stage, a 6C5 as phase inverter, and two 6L6's in the output power stage. When the receiver was switched for receiving a.m.w. the limiter and f.m.w. demodulator were, of course, replaced by a conventional detector comprising a 6J7 connected as a diode.

The receiving antenna carried on the car consisted of a conventional short non-grounded vertical rod. The receiver output could be fed either to a loudspeaker or to a 2-scale copper-oxide voltmeter, so that either aural observations or quantitative measurement the results of which are given below was possible. The selectivity curve of the receiver had a total width of 220 kilocycles at 6 decibels down, and a total width of 530 kilocycles at 60 decibels down. The frequency-response characteristic of the audio system of the receiver was flat within ± 2 decibels from 60 to 10,000 cycles. The relation between the direct current produced at the detector and the signal input from a Ferris signal generator as applied to the receiver input terminals was used to measure the values of the signal input in the tests.



Power Input 325 Watts
Power Input 625 Watts
Fig. 2—Views of 50-watt Transmitters Used at Schenectady.

FIELD TESTS

In the field tests the following three types of measurements were made:

- (1) Value of the ratio of signal-plus-noise to noise alone with various input-signal levels and three distinctive kinds of noise;
- (2) Various measurements with the two transmitting stations operating at the same frequency; and
- (3) Various measurements with the two transmitting stations operating at frequencies differing from one another by various small differences.

Measurements with Only Internal Receiver Noise

For this test, observations were made in areas free of external noise, such as fields in rural sections, well removed from power lines. Under these conditions receiver output measurements were made of the noise when receiving an unmodulated signal, and of the combination of noise and signal when receiving a modulated signal. The results of these measurements are given in Figure 3 for the two types of modulation and for a range of signal inputs from below 1 microvolt to 100 microvolts. The ordinates in this figure are the ratio, expressed in decibels, of signal-plus-noise output of the receiver to noise output alone; that is the ordinates give, in decibels, the increase of receiver output which occurred when the modulation was applied at the transmitter.

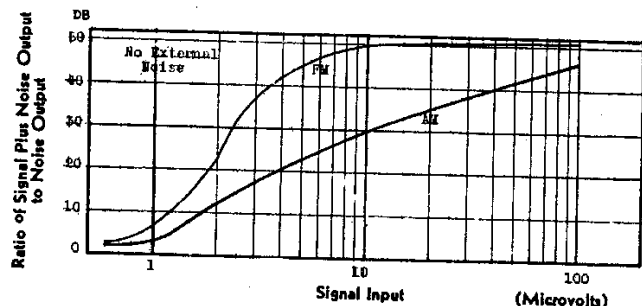

Fig. 3—Ratio of Signal Plus Noise to Noise Alone in Output of Receiver with No External Noise. "FM"—Frequency Modulation, and "AM"—Amplitude Modulation.

It may be seen in Figure 3 that at a given input level a markedly better ratio of signal output when transmitter was being modulated to the noise output-transmitter unmodulated is obtained with frequency modulation than that obtained with amplitude modulation. Or conversely, for any given desired output ratio of signal plus noise to noise, alone, which experience

may indicate is required for satisfactory service, considerably less signal input and hence considerably less transmitted field strength is required with frequency modulation than with amplitude modulation.

The flattening off of the frequency-modulation curve above signal inputs of 10 microvolts was attributed to the fact that at these higher levels of signal input, the observed noise was largely that originating in the speech amplifiers of the transmitter thus limiting the maximum possible value of the ratio of signal-plus-noise to noise to the value of this ratio in the signal itself, namely about 50 decibels. As against this, the susceptibility of the amplitude-modulated system to locally generated noise was such that even with inputs in excess at 100 microvolts no such favorable ratio was reached.

Measurements with External Noise Representative of Business Section

In these tests observations were made in areas where there was fairly high external noise, such as might be expected in a down-town business area. The data on the ratio of signal-plus-noise to noise, alone, are shown in Figure 4 for this condition. Viewed either from the standpoint of the ratio of signal-plus-noise to noise resulting from a given signal input or of the input required for any acceptable ratio of signal plus noise to noise it is obvious that under the conditions of the external noise here met the superiority of f.m.w. over a.m.w. is even greater than that indicated above.

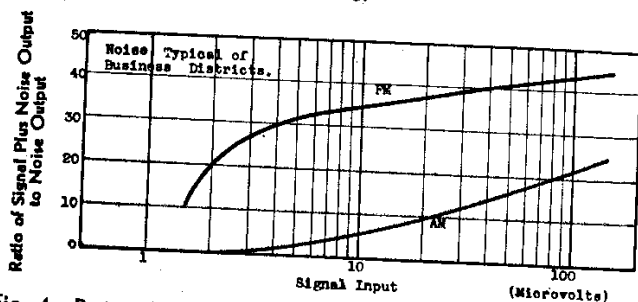

Fig. 4—Ratio of Signal Plus Noise to Noise Alone in Output of Receiver in the Presence of Noise Typical of Business Districts.

Measurements with Ignition Noise from Car Motor

For this test, observations were made at quiet locations, similar to those where were taken the data of Figure 3. Here the rear wheels of the Ford which carried the receiver were jacked up and the motor operated at motor speeds corresponding to car speeds between 30 to 90 miles per hour. For the purposes of these observations, no radio noise suppressing equipment were in place. Under these conditions the observations of the ratio of signal-plus-noise to noise alone were again made, and are shown in Figure 5. In this case observations were made sufficiently near to the transmitters to allow of measurements with signal inputs up to 500 microvolts. Again the great superiority of the f.m.w. system over the a.m.w. system is obvious.

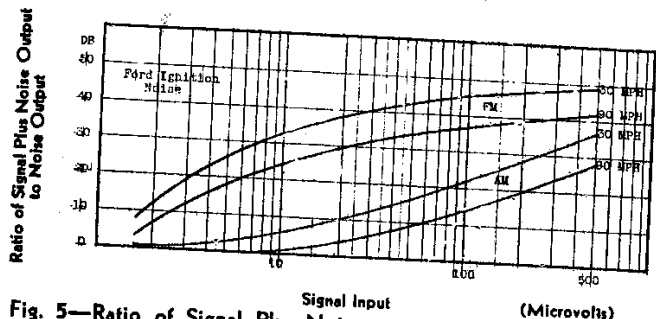

Fig. 5—Ratio of Signal Plus Noise to Noise Alone in Output of Receiver with Ignition Noise.

Observations with Both Transmitters on the Same Frequency

Tests were made with the two f.m.w. transmitters operating simultaneously on 41 megacycles but carrying distinctive programs so that they could be readily identified. One of these tests consisted in measurements of the receiver input signal level along the road between Albany and Schenectady, giving the results shown in Figure 6. Only the Albany program could be heard while driving from Albany toward Schenectady for a distance of 10.8 miles while only the Schenectady program could be heard for a distance of 2.7 miles from Schenectady. Within the intermediate region, of about two miles in width, one or the other program could be heard. Only rarely, however, could both programs be simultaneously heard. For the most part it was found in this region that either program could be replaced by the other if the car and its antenna were moved backward or forward only a few inches; indeed, it was reported that only by extremely careful positioning of the antenna could both programs ever be heard at once. The region of about two miles width in which either program could be heard is indicated by cross-hatching in the Figure.

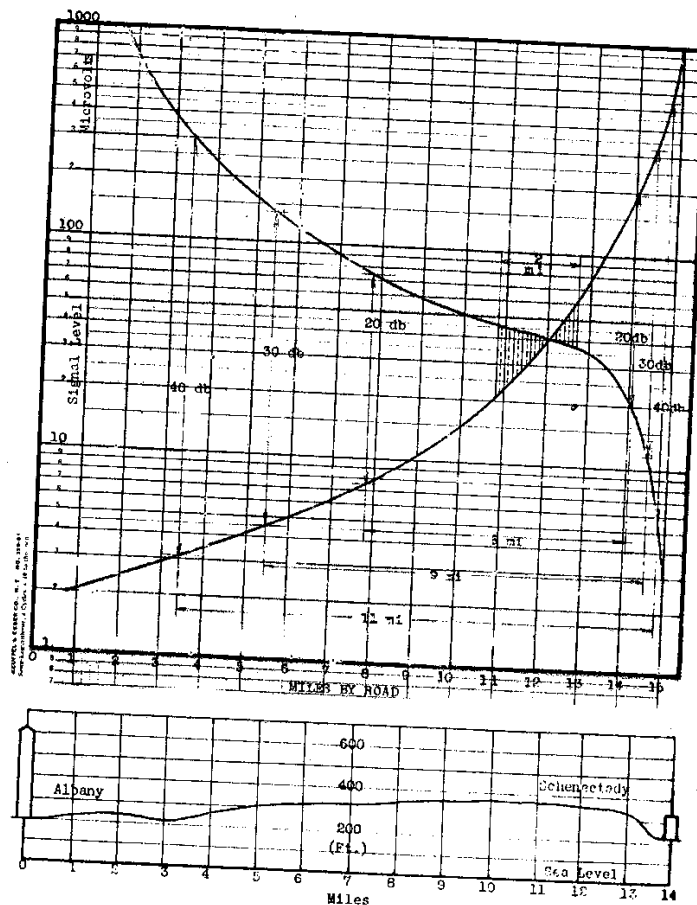

Fig. 6—Signal Strength between Albany and Schenectady Transmitters.

For amplitude modulation, additional observations were made, but the results are actually given by the data shown in Figure 6, since the signal strength at a given distance is unaffected by the type of modulation. For the evaluation of the interference area with amplitude modulation it may be assumed that the signal-to-interference ratio at the output of the receiver is the same as that at the input. Thus assuming, for example, that experience dictates that for satisfactory service it is necessary to have a 30-decibel value for the ratio of the desired to the undesired signals, the curves of Figure 6 indicate that

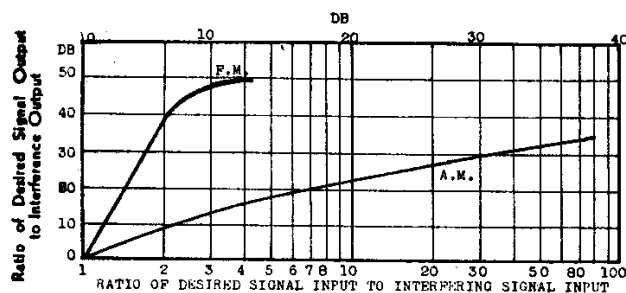

Fig. 7—Ratio of Signal Output to Interference Output of Receiver, the two Transmitters Being Modulated by Different Pure Audio Tones.

interference between the two stations would occur over 9 miles of the 14 miles between the transmitters. While for other values of the ratio of desired to undesired signals, such as the values of 20 db and 40 db, shown in Figure 6, other interference areas result.

A second series of tests were made with both transmitters operating on the same frequency. The Albany transmitter was modulated at 700 cycles and the Schenectady one at 400 cycles and the receiver outputs at these audio frequencies measured with a wave analyzer. Some of the data taken in these tests are given in Figure 7. It may be noted here that a ratio of 40 decibels between the desired and interfering signals was obtained with frequency modulation when the input ratio is only two to one, or 6 decibels. A corresponding ratio of signal to interference with amplitude modulation is seen to require a far greater input ratio, indeed it is to be noted that by extrapolation of the lower curve of Figure 7 a ratio of desired to undesired signal of this same value, i.e. 40 db requires an input signal ratio of about 100 to 1 or 40 db, as was to be expected.

Tests with Transmissions on Adjacent Frequencies

In one of these tests the Albany transmitter was operated at 41 megacycles and the Schenectady transmitter at 41.5 megacycles, carrying distinctive programs for purposes of identification. Observations were made with the receiver in the automobile throughout the intervening distance. With the receiver tuned to the 41-megacycle signal from Albany there was no point over the entire distance between the two cities at which the Schenectady signal on 41.5 megacycles could be heard. This test included parking the test car directly under the Schenectady antenna at which point still only the Albany program was reproduced.

This test suggested the making of observations with a decreased difference between the frequencies of the stations. The frequency of the Schenectady transmitter was therefore reduced to 41.25 megacycles, the test conditions otherwise remaining the same. In this case interference was encountered

only when the test car came within one-half mile of the Schenectady antenna.

In a third test a determination was made of the minimum frequency separation required in order that the receiver might operate under the Schenectady antenna and reproduce only the Albany program. The result of this test was that the required frequency interval was 360 kilocycles. The field-strength ratio under the Schenectady antenna was in excess of 10,000 times that of the Albany transmitter.

Conclusions From Experimental Observations

1. The design, construction and operation of a frequency modulated transmitter need be no more complicated nor markedly different as to details from that of an amplitude modulated transmitter.
2. The frequency modulated transmitter can be smaller, lighter, and more economical of power than the amplitude transmitter of the same power rating.
3. The f.m.w. receiver can be about equal in size and weight to the am receiver.
4. A given area can be satisfactorily served by means of frequency modulation with considerably less power than by means of amplitude modulation.
5. A given transmitter power will provide service to a markedly larger area or with a markedly lower noise level when employing frequency modulation than when employing amplitude modulation.
6. Simultaneous operation of f.m.w. transmitters on the same frequency with a given degree of interstation interference can be carried on with relatively minute geographical separation between transmitters as compared with that required for the similar operation of am transmitters.
7. The number of f.m.w. transmitters that might be simultaneously operated within any large area on a given number of fm channels and with given permissible interference areas is so great as compared with the number of a.m.w. transmitters that might be so operated as to more than compensate for the width of the frequency band required to take substantial advantage of the superiority of frequency modulation.

Analysis For Serving a Large Area

Making reasonable assumptions of propagation characteristics, the existence of level terrain, the same total frequency band, etc., computation was made of the requirements for serving a large area using frequency modulation, and also using amplitude modulation. A signal-to-noise ratio of 30 decibels at the speaker was assumed.

This extensive analysis led to the conclusion that the cost of rendering such service was far less by frequency modulation, and that in fact frequency modulation is the only system which is worthy of consideration for use in an ultra-high-frequency broadcast network.

A NEW ARMSTRONG FREQUENCY-MODULATED WAVE RECEIVER

By G. W. Fyler and J. A. Worcester*

SUMMARY: The paper describes a receiver for home use developed by General Electric for the reception of high-fidelity frequency-modulated broadcasts having carrier frequencies in the range from 41 to 44 megacycles. The receiver employs a total of twelve tubes and includes a radio-frequency stage, three intermediate-frequency stages with a pass band totaling 200 kilocycles in width and located in the neighborhood of 3 megacycles, followed by a limiting intermediate-frequency stage, a detector of frequency-modulated waves a high-fidelity audio amplifier, and a high-fidelity loudspeaker. The receiver includes discrimination against the higher audio frequencies to the extent contemplated for proper operation with the pre-emphasis on these frequencies at the transmitter. This amounts to 8 decibels at 5000 cycles and 16 decibels at 10,000 cycles.

The limitations of conventional broadcasting systems employing amplitude modulated waves are well-known. These restrict both the audio frequency and dynamic ranges that can be satisfactorily transmitted. Additionally interference with desired transmissions by radio noise or other radio transmissions inevitably impose severe limitations on the area to be served or on the service rendered. In contrast to these limitations, radio transmission by means of frequency modulated waves in the ultra-high-frequency band offers the means for the avoidance of any important limitation on the dynamic range which renders unnecessary the use of volume compression either automatic or the more commonly employed manually controlled; it permits the transmission of the upper audio frequency ranges; it greatly reduces the interfering effect of radio noise, and, of course, completely eliminates the 10-kilocycle inter-channel beat which is characteristic of conventional frequency assignment practises.

The f.m.w. receiver which is here described was designed by the Bridgeport group of the G. E. Co. to realize many of these advantages.

General Arrangement of Receiver

In Figure 1 is shown a diagram of the receiver.

The receiver is tunable over the frequency range of 41 to 44 megacycles. The intermediate-frequency stages, operating at about 3 megacycles as well as the radio-frequency couplings, provide sufficient band width to accommodate a frequency deviation or swing of ± 100 kilocycles.

Radio-Frequency Amplifier

The radio frequency amplifier tunable from 41 to 44 megacycles gives suitable image rejection and serves, as well, to give satisfactory performance in regard to thermal and tube noise. The tuning range of 41 to 44 megacycles is obtained by the use of a variable condenser of well standardized design in which the plates are reduced to a total of five per section, with about three times the usual spacing between plates and having a maximum capacitance of 25 micro-microfarads per section. Care in the choice of the capacitance range and details of construction results in a negligible acoustic feedback and a minimum difficulty in oscillator tracking. Alignment trimmers are provided at the high-frequency end of the range but none at the low-frequency range. Trimmers including a dielectric of mica treated to improve the resistance to temperature and humidity effects are employed in the antenna and interstage circuits of the radio-frequency amplifier. In the oscillator circuit a trimmer of the air-dielectric type is employed.

The radio-frequency transformers are "tri-filar," two of the windings comprising the secondary and the third comprising a low-impedance primary. The bifilar secondary thus obtained is a convenient manufacturing expedient in place of a single large conductor. The primary of the antenna transformer is tapped at the center to provide a ground connection for a balanced transmission line.

Intermediate-Frequency Amplifier

Three stages of intermediate-frequency amplification are employed to obtain sufficient gain. The transformers are of the conventional double-tuned type, each of the four of which are provided with a damping resistor of 15,000 ohms connected across the primary. This damping sufficiently widens the selectivity curve to yield the necessary 200-kilocycle pass band

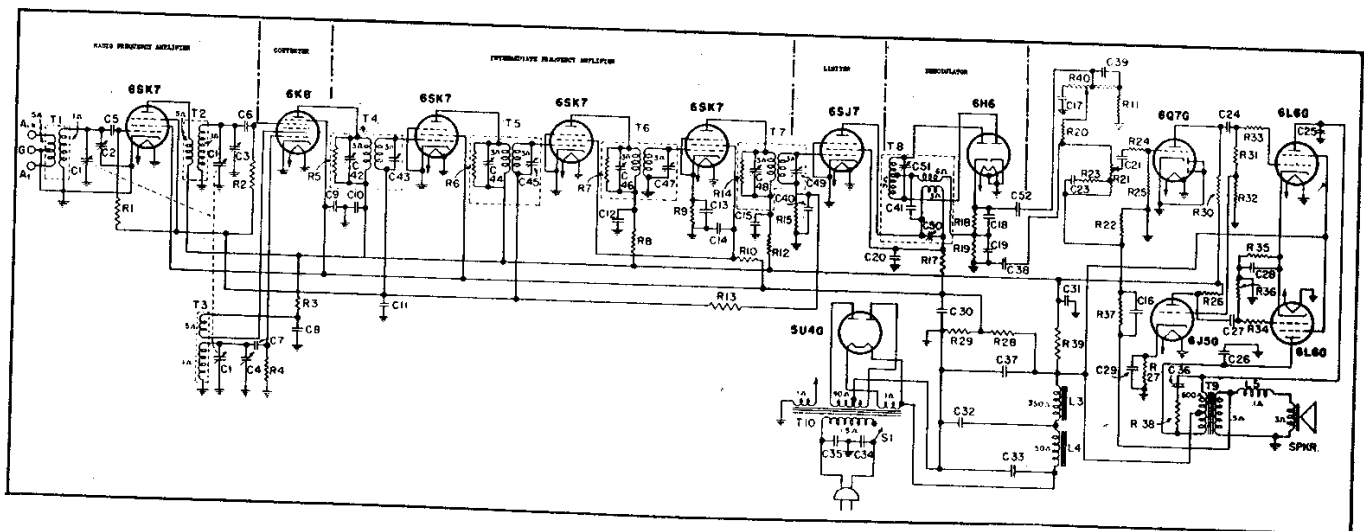

Fig. 1.

(*) General Electric Co., Bridgeport, Conn.

while providing a gain of approximately 15 times, or 24 decibels, in each stage.

Limiter

Since in the system of frequency modulation for which the receiver is designed it is essential that amplitude modulation be eliminated before detection or demodulation, an amplitude limiting stage is included. The limiting action is supplied by a 6SJ7, sharp-cutoff pentode in such circuit arrangements and at such operating voltages as provide limitation of the output amplitude in both the positive and negative directions of the carrier swings. In the positive direction the limiting action takes place by virtue of grid current flowing through a grid-return resistor of 330,000 ohms, there being no initial bias for the tube. In the negative direction the tube limits the swing due to operating at such low plate and screen voltages that plate-current cutoff occurs. The limiter circuit thus provides symmetrical cutoff by grid current on the positive swing and of plate current cut-off on the negative swing.

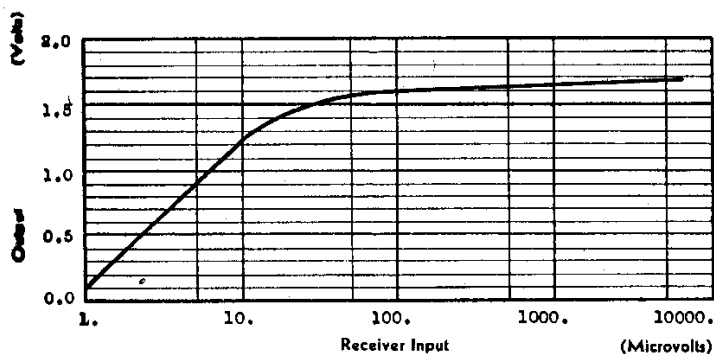

Characteristic of Limiter
Fig. 2

The direct voltage developed across the grid-return resistor of the limiter is used for the automatic volume control of the radio-frequency stage, the converter as well as of the first and second stages of the intermediate frequency amplifier. This gives a satisfactorily wide range of a.v.c. leaving the third intermediate stage tube operated at fixed bias and high gain in the interest of obtaining suitably high signal levels at the limiter input. The operating characteristic of the limiter may be noted from Figure 2 in which the relation between the output of the limiter and the input to the receiver is shown.

Detector

The circuit of the f.m.w. detector, as shown in Figure 1, is generally similar to the circuits of the frequency detector or discriminator common to conventional automatic-frequency-control arrangements. As in the discriminator, two symmetrically arranged diode detectors are used, and the magnitudes of the relative voltages on these vary according to the direction and amount by which the instantaneous frequency differs from the mid-frequency or carrier. The fixed condenser from the tuned plate circuit of the limiter to the center tap of the secondary provides for the application of the primary voltage to the two diode plates in phase, while the induced voltages developed in the two halves of the secondary are applied in phase opposition. The condensers across the two halves of the diode load resistor are small enough to prevent loss of the audio-frequency output but large enough to short-circuit these resistors for the intermediate frequency. The variable condenser in the tuned limiter plate circuit and in the tuned diode input circuits are of course tuned to the intermediate-frequency carrier. For high-fidelity operation the relationship between the instantaneous output audio voltage of the frequency detector and the instan-

taneous input carrier frequency swing should be precisely linear out to about 100 kilocycles either side of the mid-frequency of the intermediate amplifier. The extent to which this is realized in the circuit here discussed may be seen in Figure 4 in which is given the output audio voltage for a range of carrier swing up to 200 kilocycles.

This detector has improved sensitivity of the order of 100 to 1 as compared with the earlier forms of f.m.w. detector circuits comprising a series circuit tuned to the mid-frequency with suitable linearizing resistance and delivering an output across one of the reactive elements.

Audio Amplifier and Speaker

The audio amplifier includes a first audio stage and a phase inverter, which together feed beam power output tubes in push-pull. Overall audio degeneration is used by connection from the voice coil of the speaker back to the input of the first audio stage. Excessive audio phase shifts are guarded against by the use of an output transformer of high inductance, large coupling capacitors, and other means.

Since it is intended that this receiver be used with transmitters in which pre-emphasis of the high frequencies it is necessary to incorporate the complementary de-emphasis in the circuits of the receiver. In Figure 4 is shown the pre-emphasis, of the transmitter and the approximately equal and opposite de-emphasis provided in the receiver. The resultant overall curve can be seen to be almost flat to above 10,000 cycles. More specifically, the pre-emphasis as referred to the gain at 400 cycles, is approximately 3 decibels at 2000 cycles; it is 8 decibels at 5000 cycles; 16 decibels at 10,000 cycles; and 26 decibels at 20,000 cycles. To yield the necessary discrimination against high frequencies in the receiver the de-emphasis is obtained thru the use of a simple resistance-capacitance high-frequency attenuator.

As shown in Figure 4, the electrical fidelity characteristic is flat within ± 2 decibels up to 20,000 cycles. The acoustic fidelity characteristic—not here shown—is flat to within ± 5 db up to 15,000 cycles. The non-linear distortion of the amplifier was held to $\frac{1}{2}$ percent when delivering 8 watts. Included in the receiver is a single speaker unit having such

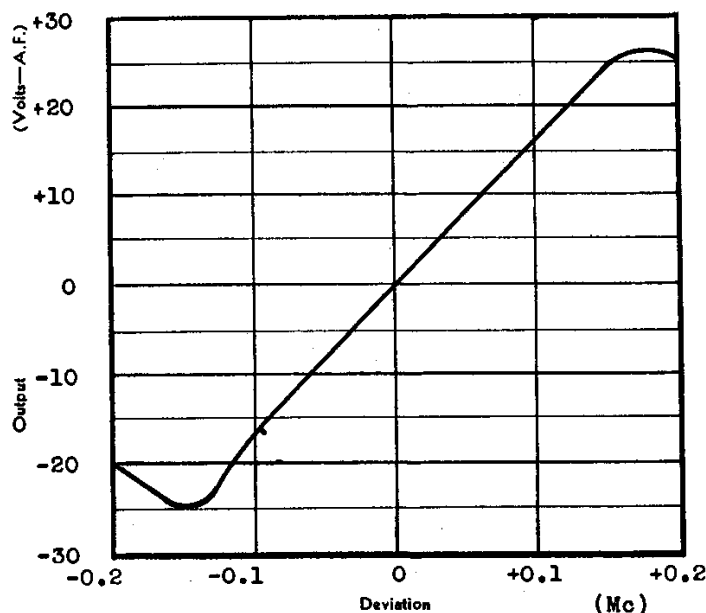

Characteristic of Demodulator
Fig. 3

special features as, in part, account for the unusual acoustic fidelity. The cone is joined tangentially to the voice coil in a horn-like manner, the whole having an approximately parabolic shape. This construction improves the high-frequency response while the carpinchoe leather used in outer suspension serves to reduce reflections at this point.

A bass-compensated volume control is provided while for those who must have one a tone control is provided. It is so arranged that the high-fidelity position is in mid position, while emphasis on the lows and on the highs is obtained on opposite rotations from this position.

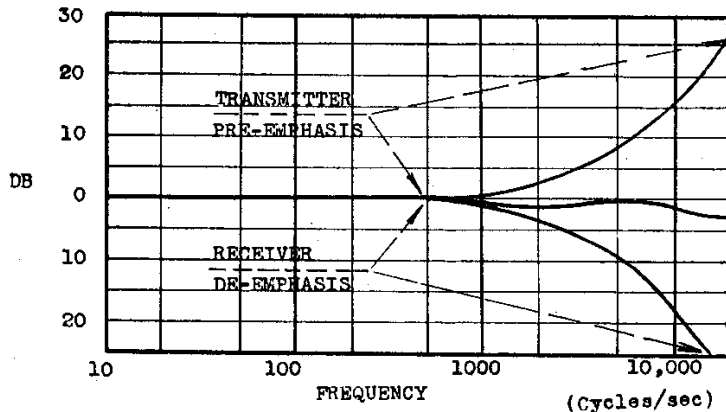

Fig. 4

DEMONSTRATIONS

The presentation of the two papers was followed by demonstrations of f.m.w. broadcasting directed by Prof. Armstrong, thru his station W2XMN at Alpine, New Jersey, operating with a power of 20 kilowatts and at a frequency of 42.8 megacycles and thru Mr. Runyon's amateur station, W2AG, at Yonkers, N. Y., operating f.m.w. with 600 watts on 110 megacycles. Various types of program material both of the recorded and studio varieties, were presented and the fidelity was generally considered excellent.

As an especially interesting means of indicating the capacity of his frequency modulation system for discriminating against noise interference the power of the transmission was reduced by the brutally effective means of cutting off the final amplifier at the Alpine station, leaving only such power for transmission as was passed thru the neutralizing circuits. The reception of the program continued with a perceptible but by no means troublesome noise. The power supply was next cut off of the preceding stage, and fair reception was still obtained.

Prof. Armstrong announced that a suitably high fidelity telephone line was being installed between the studios of the high-fidelity station WQXR and the Alpine transmitter, and would shortly be in use for the broadcasting of WQXR's programs from Alpine by frequency modulation.

DISCUSSION

In response to a question, Major Armstrong reported that he has not noticed anything like selective fading at 40 or 110 megacycles. In response to another question he stated that he regards 100 miles as the working range of his Alpine station W2XMN (undoubtedly considering its full 40-kilowatt output). He also stated that a 10-kilowatt f.m.w. transmitter on the ultra-high frequencies may safely be expected to exceed in performance a 50-kilowatt station in the 1 mc. broadcasting band. Prof. Armstrong emphasized the point made by Mr. Weir that from the standpoint of the necessary equipment

and power capacity, the 10 kilowatt f.m.w. transmitter corresponds to an a.m.w. transmitter of only $2\frac{1}{2}$ kilowatts.

Mr. Paul A. DeMars of the Yankee net work reported that construction was in progress on a 50-kilowatt f.m.w. station at Paxton, near Worcester, Massachusetts, stating that he expected to be operating with a power of 2 kilowatts in a few months. This point is more than 1000 feet above sea level and the station construction includes a mast with a height of 400 feet. Mr. DeMars also reported that on Mount Washington in New Hampshire a 500-watt amplitude-modulated station was now operating, and that equipment for frequency modulation of this station will be installed later. He stated further that the Yankee Network plans to cover substantially all of New England by f.m.w. from a limited number of stations.

Frequency-modulation developments in Connecticut were reported on by Prof. Daniel Doolittle, of the Dept. of Electrical Engineering, of Connecticut State College, Storrs, Connecticut. He stated that a station W1XPW on Meriden Mountain, located at about the center of Connecticut, with a height of 1000 feet above sea level, was under construction and would be on the air in a few weeks. This station will have a power of 1 kilowatt and an antenna height of 94 feet above ground. The transmitting frequency will be 43.4 megacycles and it is expected that a range of 50 miles or more will be covered.

Professor Doolittle reported the reception of W2XMN, the Alpine station, at North Haven, Connecticut, a distance of 65 miles, using the General Electric receiver described by Mr. Fyler when using as the antenna a short length of lamp cord opened at the end and lying on the ground.

BIBLIOGRAPHY

For a general account of frequency modulation including analysis of the side frequencies, reference may be made to the paper, "Frequency Modulation" by B. van der Pol, Philips Incandescent Lamp Works, Eindhoven, Holland, in the PROCEEDINGS OF THE INSTITUTE OF RADIO ENGINEERS for July 1930, pages 1194-1205.

Professor Armstrong's development of wide-swing frequency modulation for the improvement of signal-to-noise ratio was presented before the Radio Club in the 1935-36 season and, his complete paper was published in the PROCEEDINGS OF THE INSTITUTE OF RADIO ENGINEERS for May 1936, pages 689-740, under the title "A Method of Reducing Disturbances in Radio Signaling by a System of Frequency Modulation."

The side frequencies in frequency modulation occur in amounts determined by Bessel functions and a set of convenient curves for computing these were published by Murray G. Crosby in the PROCEEDINGS OF THE RADIO CLUB for December 1938, pages 73-74.

The reason that an increase of frequency swing with frequency modulation produces an improvement in signal-to-noise ratio has been given by Hans Roder in an article, "Noise in Frequency Modulation," in ELECTRONICS for May 1937, pages 22-25, 60, 62, and 64. In this connection reference may also be made to a few paragraphs by H. A. Wheeler in ELECTRONICS for December 1935, page 508.

A brief review of the side band equivalents of frequency modulated waves, a report of interesting experiments with simple transmitter and receiver circuits and a detailed and more complete list of references to the literature on the subject is given by C. B. Fischer in the R.M.A. ENGINEER for November, 1938, pages 11 to 15.