

Proceedings
of the
Radio Club of America
Incorporated



November, 1934

Volume 11 No. 6

RADIO CLUB OF AMERICA, Inc.
11 West 42nd Street + + New York City

November, 1934

The Radio Club of America, Inc.

11 West 42nd Street - New York City

TELEPHONE—LONGACRE 5-6622

OFFICERS FOR 1934

President

H. W. Houck

Vice-President

R. H. Langley

Treasurer

J. J. Stantley

Corresponding Secretary

F. A. Klingenschmitt

Recording Secretary

J. K. Henney

DIRECTORS

E. H. Armstrong

E. V. Amy

L. C. F. Horle

B. F. Miessner

Frank King

H. Sadenwater

G. E. Burghard

C. W. Horn

H. H. Beverage

R. H. Barclay

J. H. Miller

Frank M. Squire

W. G. H. Finch

COMMITTEES

Papers—F. X. Rettenmeyer

Publications—L. C. F. Horle

Membership—C. W. Horn

Entertainment—F. Muller

Forum—R. H. Langley

Club House—G. Burghard

Publicity—W. G. H. Finch

Affiliations—Fred Muller

Year Book-Archives—R. H. Mariott

Finance Committee—E. V. Amy, J. J. Stantley, L. C. F. Horle

Business Manager of Proceedings—R. H. McMann

PROCEEDINGS of the RADIO CLUB OF AMERICA

Volume II

November, 1934

No. 6

THE BROADCAST ANTENNA

BY

A. B. CHAMBERLAIN and WILLIAM B. LODGE*

Delivered before the Radio Club of America
November 15, 1934

The design of a broadcast antenna is governed largely by commercial considerations. A broadcast transmitter whose income is derived from advertising sales must usually concentrate on its primary service area. This may be defined as the area in which any home having an average receiver, and desiring to listen to the program transmitted can receive a satisfactory signal, free of noise and fading. Uncertain, irregular reception at long distance has some prestige value, but it seldom contributes to the income of the station, since, in general, the broadcast receiver is now used to bring entertainment into the home with little interest being shown in the fading noisier signal of distant transmitters.

In broadcasting, the power output of the transmitter is limited, both by economic and regulatory factors. The problem, then, is to concentrate all of the available radio frequency power on the local service area. Only a small fraction of this power is now directed at the population it is desired to serve.

Increasing the signal intensity in a horizontal direction is only part of the problem in the case of higher powered transmitters, nighttime fading starts many miles before the field intensity becomes too weak for a satisfactory signal. Radiation above the horizon is completely lost during the day-



light hours, this power being robbed from the useful signal. At nighttime, however, conditions are changed so that some of the radiation at angles between 40° and 70° above the horizon is returned to earth 40 to 150 miles from the transmitter. This reflected signal is of negative value since its variation in phase and amplitude causes it to interfere with the signal arriving directly from the transmitting antenna. At night the local service area ends at a point where the reflected signal approaches the directly transmitted signal in intensity.

It is fair to say that many experienced antenna engineers doubt the probability of redirecting this high angle radiation and concentrating it along the horizon. Such a development in broadcast antennas would increase the commercial value of the radio station far more than a simple increase in transmitted power. We believe the limit has by no means been reached in the improvement of transmitting antennas.

Before reviewing what has already been accomplished in this line, let us see what happens to a watt of carrier power leaving the last amplifier in a broadcast transmitter. The output of a radio station is usually fed to the antenna over a transmission line. The r-f power is then dissipated as follows:

* Columbia Broadcasting System

1. Radiation

- (a) Along the horizon to potential receiving sites. Usually the zone between 0 and 5 degrees above the horizon includes all such sites.
- (b) Towards the ground; partially reflected back at angles above the horizon and partially dissipated in the earth.
- (c) Into space; either lost or reflected back to potential receiver sites; causes fading; gives long distance reception.

2. Transmission line loss

3. Coupling equipment loss

- (a) Resistance in units.
- (b) Transfer of r-f energy to non-radiating surfaces.

4. Resistive loss of ground system

5. Dielectric loss at base of antenna

6. Resistive loss of actual antenna

7. Power picked up by nearby metallic objects (towers, guys, power wires, building framework, etc.) and either dissipated or reradiated.

There are other losses which absorb smaller percentages of the radio frequency power. However, of the divisions of power listed above, only the first one - radiation along the horizon - is of value to the broadcaster.

There is little accurate quantitative data available as to the strength of the signal radiated above the horizon by different types of antennas.^{1,2} In the case of the vertical radiator there have been extensive mathematical discussions giving the signal distribution in a vertical plane.^{3,4,5,6} Attempts have been made to fix the exact height of a vertical radiator to minimize sky-wave signal at points which would otherwise remain outside of the primary service area of the station. To make actual check of this theory in practice requires airplane measurements above the antenna or an extensive study of the reflected sky wave at various distances from the transmitter.

In the case of the lower powered stations on shared basis, the fading is not usually a consideration of importance. In these stations, therefore, the first consideration is to obtain the maximum signal at one mile. In the case of the high power, clear channel stations, however, the usable signal extends out into the zone which is affected by fading. At these stations it is important to consider both efficiency and fading characteristics of the antenna.

CLARIFICATION OF ANTENNA TERMS

Before going further, it would be well to clarify certain terms commonly used in connection with certain antennas. The terms to be clarified are:

1. "Antenna Efficiency".

2. "Antenna Length".

One of the most commonly used terms in connection with antennas is "radiation efficiency" or "antenna efficiency". And there are almost as many definitions for it as there are engineers in the field. Theoretically, this efficiency should represent the ratio of the radiated power to the input power of the antenna. However, it would be necessary to integrate the power streaming away from the antenna toward every point in space to determine such a figure. As this is not a practical procedure, measurements of field strength are usually made at convenient points on the ground near the antenna. Among American engineers the field intensity at one mile is the value usually determined, but in the formulation of a figure of merit many different arbitrary standards have been used as a basis of comparison. Thus, 100, 123, 187, 194 and 265 millivolts per meter at one mile for 1 kw have at various times all been called "100% efficiency".

In addition, since the field strength of any station is proportional to the square of the power, some engineers square the "field strength efficiency" and obtain "power efficiency". Actually, whatever the means used to express it, "antenna efficiency" can only tell the engineer the signal in millivolts per meter at one mile at the earth's surface for a certain antenna input. Efficiency ratings at present are very ambiguous, and since there appears to be no one fundamental value upon which to base efficiency ratings, it is hoped that the method of rating antennas simply in terms of signal output will be adopted generally by engineers.

The Engineering Department of the Federal Communications Commission has arbitrarily defined the definition of "antenna efficiency" as follows:⁷ "The antenna efficiency equals 100% if the effective field intensity of the station at one mile, per 1 kw antenna input power, is equal to 265 millivolts per meter".

$$A_{\text{eff}} = \frac{F^2 \times 100}{265^2 \times P}$$

F = Effective field intensity at 1 mile.
P = Antenna input power (in kw)

The root mean square value of all field intensities at one mile from the antenna in the horizontal plane without attenuation is termed the "effective field intensity" (F).

Early antennas were described in terms of their fundamental wavelength. This was the longest wavelength at which the antenna had zero reactance and the mode of operation of the antenna was given by the ratio of operating wavelength to fundamental wavelength.

Theoretically, a vertical wire antenna will have zero reactance whenever it is any number of quarter wavelengths long; that is it will then have zero reactance when its length is one quarter, one half, three quarters, etc., of a wavelength. Practical measurements indicate however, that a vertical wire antenna for zero reactance is about 4% shorter than the above values - that is, the velocity of propagation along the wire is apparently .96 of the free space velocity.

Referring to the impedance characteristics of the guyed mast, Figure 1, a "half wave" antenna of this type is physically only .45 of a wavelength high. Following the above method of argument, it would be said that the propagation velocity of this

type of antenna is only 90% of the theoretical velocity. Further, if reference is made to Figure 2, which gives the impedance characteristics of the self-supporting vertical radiator, it could be argued that the velocity of propagation is 66% of the theoretical velocity. In fact, a well-known radio laboratory in this country has released data to that effect, and has stated that a vertical tower, one half wavelength in physical height, is actually three quarters of a wavelength long electrically.

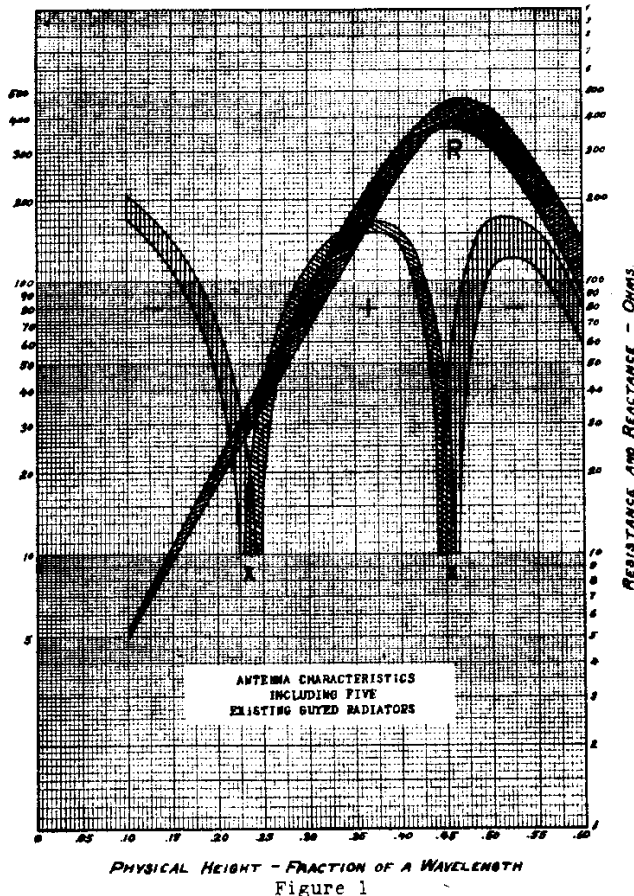

This method of reasoning is based upon the assumption of a sinusoidal distribution of current on the antenna. This assumption is not justified in practice.⁸ It also assumes there is no lumped capacitance in the antenna itself. When the equivalent circuit of the antenna is considered, it may be seen that this circuit can be tuned to zero reactance at almost any frequency by the choice of a proper shunt condenser. This is exactly what occurs in the case of the self-supporting tower.

If a four to five hundred foot guyed mast and a similar self-supporting tower of a conventional design were measured, it is estimated that the capacitance to ground of the first thirty or forty feet of the wide base tower would exceed that of the other structure by at least 800 mmf. (including insulators). Taking a .47 guyed mast, operating at 1080 kc, as an example, Figure 1 shows its impedance to be 400-j60. If an 800 mmf. condenser were shunted across the base insulator, the measured impedance at 1080 kc would be.

$$z = \frac{j178(400 - j60)}{(400 - j60) - j178} = 63 - j133$$

The impedance of this mast was thus made similar to that of a wide base self-supporting tower

which is given in Figure 2. Yet no one would argue that the velocity of propagation on the mast itself had changed.

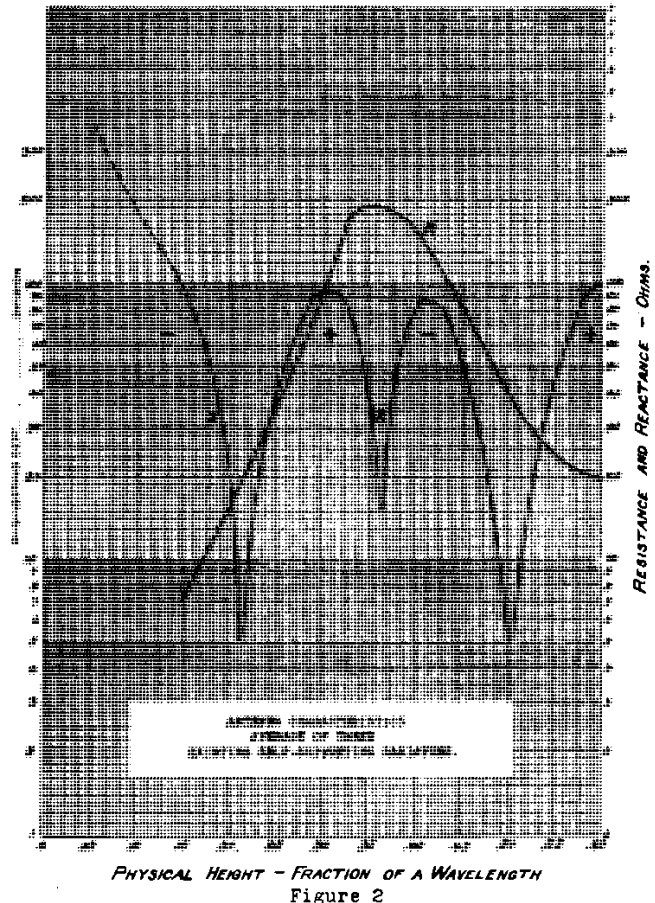

It is our belief in connection with vertical antennas involving structures whose entire length is not of uniform cross section that:

1. The terms "electrical length" and "velocity of propagation" have no significant value.
2. Engineers working with these antennas should standardize on physical height (in fractions of a free space wavelength) as a method of describing the antenna dimensions.

EVOLUTION OF BROADCAST ANTENNAE

The early broadcast antenna consisted of a pair of steel, or wooden masts supporting an antenna structure usually consisting of a vertical wire, or a vertical wire and horizontal section consisting of a flat top, or cage. This latter type was known as the "T" or "L" type antenna. It is interesting to note that more than 70% of the broadcast stations in operation today employ this older type of antenna. Most of these have a natural wavelength less than 1/4 of the operating wavelength. Later, it was realized that some gain would be made if larger antennas were employed. Therefore, the same type of antenna was used, but the natural wavelength was increased to 1/3 or 3/8 wave.⁹ In 1924, some attention was given to this problem by Dr. Stuart Ballantine^{10,11} which later resulted in the so-called .58

wave guyed vertical mast antenna. In 1931 two such antennas, designed and fabricated by the Blaw-Knox Company¹², were erected at CBS stations WNAC-WAAB, Boston; and WABC, New York. The electrical gains expected from these antennas have been realized in practice, and during the past few years a great deal of study has been given the subject of obtaining a clear picture of the electrical properties of this type of radiator. During the past two years attention has also been given to the self supporting type which has made an appearance in the field. It can be shown that the guyed type of vertical mast antenna, or the self supported type of single mast antenna, is superior to the older conventional antennas, electrically, physically and economically.

A study of Figure 3 indicates the evolution of broadcast antenna efficiencies, and shows, conclusively, that the higher mast type antenna is much better than the older conventional types from an electrical viewpoint. Early broadcast antennas resulted in an effective field intensity of as little as 100 millivolts per meter at one mile, per 1 kw antenna input power. The average of fourteen conventional type antennas, recently measured, shows that with 1 kw antenna input power, the effective field intensity is 169 millivolts per meter at one mile. The average of five self supported type mast antennas, from .20 to .35 wavelengths high, shows an average field intensity of 204 millivolts per meter, and measurements made at eight .58 wavelength antennas shows the average field intensity to be 247 millivolts per meter at one mile. There is one guyed type vertical mast antenna which has an effective field intensity as high as 280 millivolts per meter. Figure 4 indicates this same story in terms of comparative increase in power. It should be emphasized that these results are based on actual measurements and show the higher antennas to be far more efficient electrically than the older conventional types.

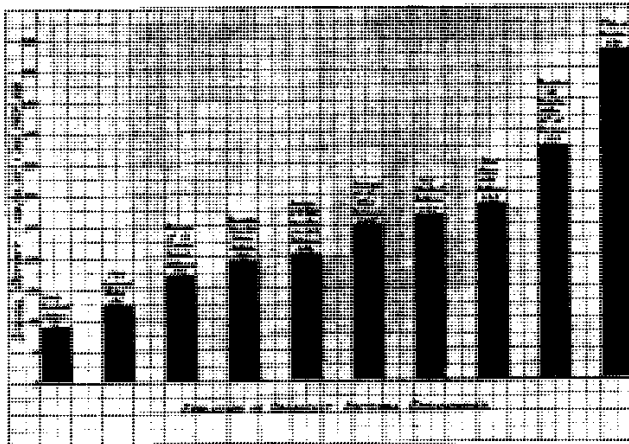

Figure 3

Either the self-supporting or the guyed radiator can be erected at less cost than a two tower conventional antenna of the same height. It has far greater reliability of operation, has a lower maintenance cost, and the horizontal polar diagram, or distribution of power, is not influenced by nearby towers, which tend not only to distort the field pattern, but also to lower the antenna efficiency. The self-supporting antenna has a very practical application in the cases of broadcast transmitters which are located in tall buildings. It is sometimes difficult to erect the older type of antenna system because of physical limitations. However, if an adequate ground is provided a moderately efficient antenna system can be erected atop a tall building

through the use of a vertical mast antenna.

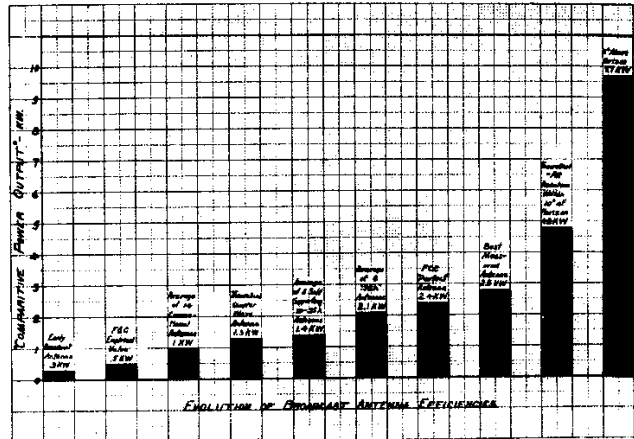

Figure 4

During the past, broadcast engineers have been very hesitant in adopting the vertical mast antenna, particularly the wide base, self-supporting type, because of a "bugaboo" which has existed with regard to high base capacitance being directly related to loss in efficiency. Station engineers have also been given to understand that it is next to impossible to couple their transmitter into such a structure because of the high reactance between it and ground.

Within the past three years a number of self-supporting towers have been erected, usually with strict limitations on insulator capacitance and tower capacitance to ground. The fear of base capacitance has continued up to the present and measurements of the signal output of these antennas operated at higher frequencies led to the conclusion that they would be unsatisfactory for use in heights greater than .35 or .40 of a wavelength. In 1934, Mr. John Byrne, working as a consultant for the International-Stacey Corporation, made measurements which showed that the loss of efficiency was due to dielectric losses in the earth near the tower. With this fact established, it was simply a matter of reducing the r-f voltage gradient in the soil at the tower base.

Self-supporting vertical antennas have appeared having the first 80 or 90 feet constructed of wood, and the radiating section above insulated from the wood. Various other modifications of the self-supporting structure were developed, including all-steel designs which insert the base insulators 20 to 30 feet above ground. Another satisfactory solution has been to construct a well grounded copper mat or ground screen beneath the tower, thus greatly reducing the high voltage normally impressed across the earth at the tower base. At station WDOJ, Chattanooga, Tenn., measurements were made recently which substantiate this point. The station uses a self-supporting tower .42 wavelengths high, and has installed two sets of insulators, one just above ground, and the other set approximately 20 feet above ground. It has been found, by making antenna resistance and impedance measurements, and also field intensity measurements at one mile, that the same antenna efficiency can be obtained using either the higher set of insulators or the lower set of insulators. However, if the lower set of insulators is used, it becomes necessary to install a ground screen to reduce the dielectric losses at the base of the antenna.

From present data on broadcast antennas, we

feel we can safely say that the same antenna efficiency can be obtained with nearly any type of vertical mast antenna of a given height, providing the necessary precautions are taken in design and erection, and providing the proper ground system is used.

In the design of a ground system, it is necessary that the voltage between the base of the antenna and the ground be accurately estimated in order to reduce the losses previously discussed. This information is also necessary in order that adequate insulation may be provided. If impedance measurements have been made on antennas of the same general shape as the one contemplated, the voltage may be determined quite accurately in advance. Contrary to popular belief, the highest voltages encountered do not always occur in high resistance antennas. For instance, a vertical radiator, now in the course of construction which will be .47 wavelengths high, will have a resistance of 400 ohms at the operating frequency. Its unmodulated 50 kw carrier voltage, at the base of the antenna, will be 4500 volts r.m.s., $\pm 10\%$. There is another 50 kw station in service, whose antenna resistance is 15 ohms. The impedance of this particular antenna is 140 ohms, so the base voltage is approximately 8000 volts r.m.s. Figures 1 and 2 show the average resistance and impedance characteristics of self-supporting and guyed vertical radiators, and may be used in estimating base losses, insulation requirements, antenna current, antenna loading and lighting circuit requirements.

THE GROUND SYSTEM

The proper design of the ground system for use with broadcast antennas has always been important, but the design of a ground system for use with high antennas becomes particularly important, because factors other than ground loss resistance must be taken into account. The radial ground system used with a high antenna should be large in diameter, having a radius equal to at least $1/2$ wavelength. It is also important that a large amount of copper be used. Figure 5 shows the empirical relationship between antenna efficiency and ground radius, based on measurements of 35 stations. The reasons for a large ground system are to reduce to an absolute minimum, ground resistance loss, dielectric losses, and the absorption of radiation directed towards the ground. Figure 5 is based on data obtained from various sources, but it is considered to be indicative of the advantages of increasing the ground radius.

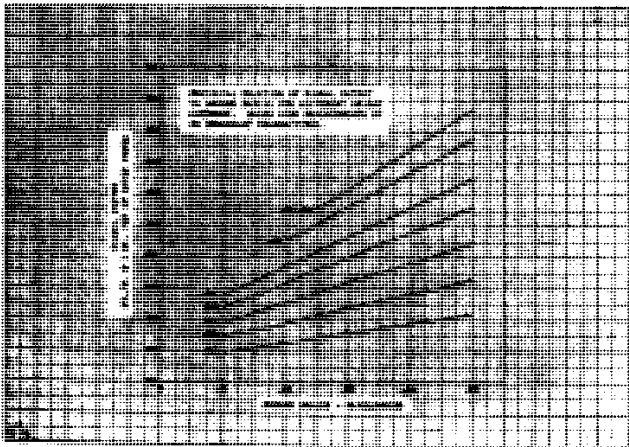

Figure 5

This paper is primarily concerned with the transmitting antenna and its associated ground system. However, the choice of a station location is definitely related to the antenna design. A site surrounded by soil of the highest possible conductivity is advisable. Actually, the final choice of a station location is governed by considerations of population distribution and coverage, so the engineer must often design an efficient radiating system above soil of poor conductivity.

If the transmitting antenna is located over poor soil, the ground current will tend to avoid the high resistance earth path and will remain on the lower resistance copper wires of the ground system. This is shown graphically in Figure 6, the current on a single ground radial at two 50 kw transmitters. The antenna and ground systems of the two stations are practically identical, but WSM at Nashville was fortunate in obtaining a station location where the soil conductivity is considerably higher than at any which were available to WABC.

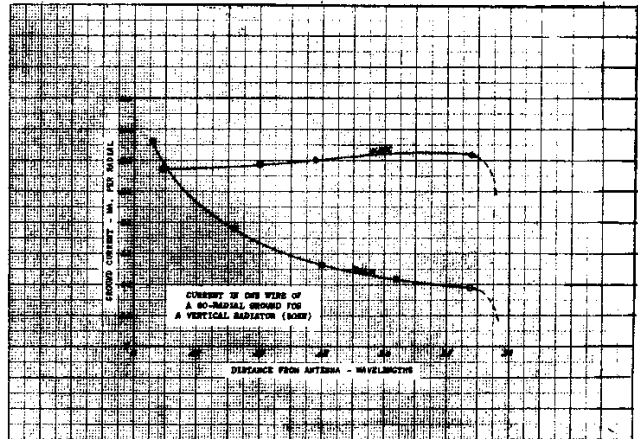

Figure 6

The effect of soil conditions also is evident in the vertical pattern of the higher types of antennas. Figure 7 shows the calculated and measured vertical polar diagram for a guyed mast antenna located in a part of Pennsylvania of comparatively low conductivity. Several studies have shown that the current distribution on an actual antenna structure departs from the assumptions which give the desirable calculated pattern of Figure 7. Earth of high conductivity is also assumed in the calculations. Sky-wave and fading measurements indicate that two other guyed mast antennas¹⁴, which are surrounded by

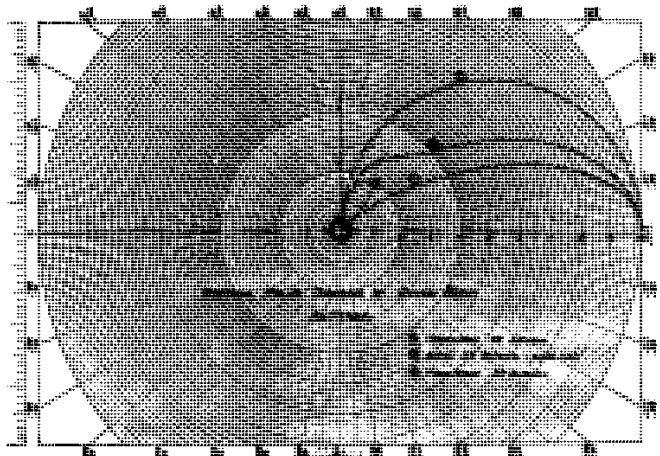

Figure 7

high conductivity soil more nearly approach the theoretical vertical pattern than similar antennas with less favorable ground conditions.

An extensive ground system increases the efficiency of any antenna, but is absolutely essential at stations which are forced to locate in areas of low conductivity.

DIRECTIONAL ANTENNAS

Directional antenna systems have been installed at stations, WJSV, Alexandria, Virginia; and at WKRC, Cincinnati, Ohio. These antennas are in operation at the present time. The purpose of employing such systems is to fulfill specific interference-reduction requirements consistent with the rendering of maximum public service.

The WJSV antenna system consists of two vertical conductors suspended between two 150 foot steel towers, insulated at their bases. The antennas are $3/8$ wave apart ($\phi = 135^\circ$) and the current in the West antenna leads the current in the East antenna by $1/8$ wave ($\phi = 45^\circ$). The 10 kw WJSV transmitter is located about four hundred feet from the antenna system and power is transmitted from it to the antenna by a conventional 600-ohm two-conductor open-wire line. Proper phasing is obtained by using transmission lines to each element of such length as to obtain the desired phase difference. The field intensity distribution in a horizontal plane is a flattened cardioid, with the minimum signal in an easterly direction. The horizontal space pattern - at one mile - is: E = 10 mv/m; N = 580 mv/m; W = 500 mv/m; S = 550 mv/m; with 10 kw antenna input. Figure 8 shows the horizontal polar diagrams of the

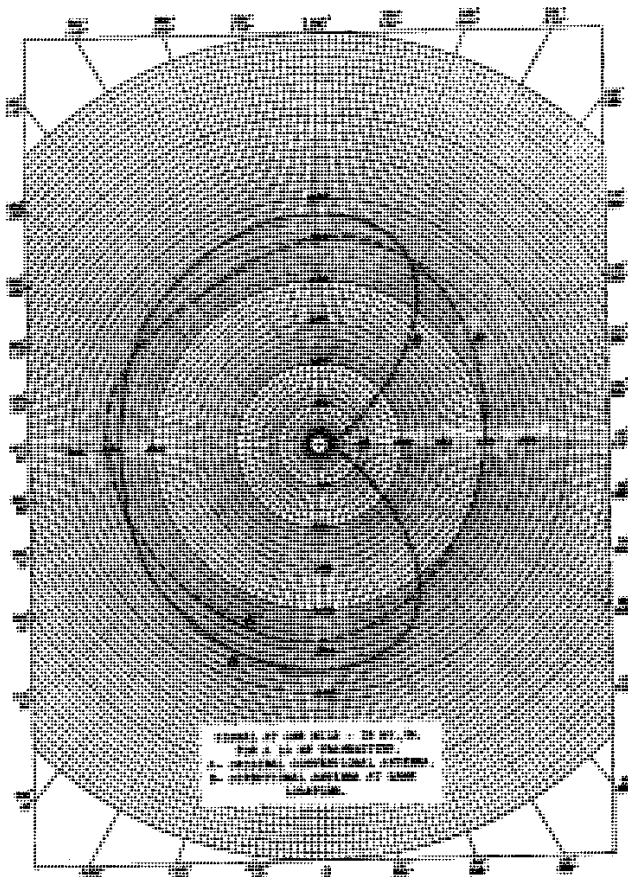

Figure 8

WJSV conventional antenna versus the directional antenna which is now in use. Optimum reduction of signal was desired, in this case, at a point one mile east of the station. It can be seen that a reduction in signal intensity of approximately 50:1 has been obtained. In order to determine the stability of the system, an accurate automatic signal intensity recorder was installed one mile east of the WJSV antenna system which records the signal strength of this station continuously. This equipment has been in operation twenty-four hours a day since July, 1933. The automatic field intensity receiver is a.-c. operated and is specially designed so that its sensitivity is independent of variations in ambient temperature, humidity and line voltage.

The records obtained during the past year indicate that the stability of the WJSV antenna system is entirely satisfactory. Inasmuch as the cardioid pattern is the most difficult to maintain, experience at WJSV has definitely shown that it is unnecessary to employ special means of maintaining stability.

The directional antenna system at station WKRC is erected on the roof of the Hotel Alms, Cincinnati, Ohio, and consists of two self-supporting towers 154 ft. high and $1/8$ wave apart. (Space, $\phi = 45^\circ$). The current in the North antenna leads the current in the South antenna by 140° ($\phi = 140^\circ$). Figure 9 shows the skeleton block schematic diagram of this system. In order to obtain the proper phasing, an artificial line is used because of the relatively short transmission lines erected on the roof. The lines themselves, being approximately 110 feet long, each have an electrical length of approximately 30° . The additional 80° is obtained by properly adjusting the artificial line. With this arrangement, the field intensity distribution in a horizontal plane satisfies the general requirements of this case. A considerable amount of data concerning the operating characteristics of directional antennas was obtained during the design, construction and adjusting of the two systems described above.

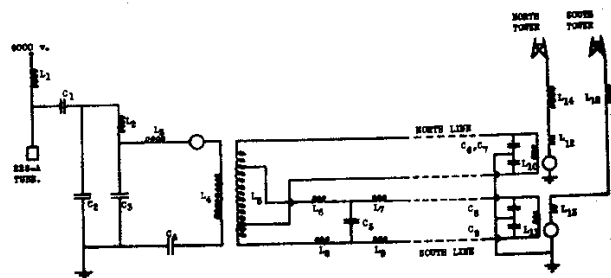

Figure 9

Schematic diagram of the WKRC directional antenna system.

Directional antennas are being used at regional stations to cut down interference in the areas served by other stations occupying the same channel, and it now appears that the use of this type of antenna will become more general in the future. Providing a directional antenna is properly designed and installed, it is possible to accurately predict its space pattern in advance^{15,16}. However, it is not always possible to predetermine the efficiency of such an antenna system. Directional antennas should find wide application when and if synchronized station operation on a large scale becomes feasible.

TOWER LIGHTING AND PAINTING REQUIREMENTS

The marking of aircraft obstructions is set forth in detail in Aeronautics Bulletin No. 16, copies of which may be obtained without charge upon request from the Aeronautics Branch, Department of Commerce, Washington, D.C. The general requirements, as they affect radio stations, are summarized below.

Skeleton towers should be painted throughout their height with either alternate bands of chrome yellow or international orange (yellow No. 4 and orange yellow No. 5, respectively, of Color Card No. 3-1) and black, or alternate bands of international orange and white, terminating with either chrome yellow or international orange bands at both top and bottom, depending on color combination used. The width of the chrome yellow or international orange bands should be one-seventh the height of the structure for all structures less than 250 feet in height and from 30 to 40 feet for structures over 250 feet in height. The black or white bands should be one-half the width of the chrome yellow or international orange bands.

For night marking an aircraft hazard, a red obstruction light consisting of a 100-watt lamp in a red waterproof globe should be mounted at the top of structure.

For radio towers, or towers having a network of wires between the towers, additional fixed red lights consisting of 50-watt lamps in waterproof globes should be mounted on diagonal corners at the one-third and two-thirds points and so arranged as to be visible from any angle of approach.

Some areas which present a hazard to flying a civil airway, may require obstruction marking for night flying by use of lights of the high-intensity fix projector type. The high intensity fixed projectors should be 24-inch parabolic units using 1,000-watt lamps with lamp changers, should be pointed so as to envelop and outline the areas over which flying should be restricted, and should be elevated so that the luminous beams of light will intersect at the height of the obstructions to be cleared. In addition, such hazardous flying areas should be marked with one or more certified landmark beacons as conditions may require to give pilots a long range warning. Such beacons should be similar to the 300-millimeter airways electric code beacons of the double-Fresnel lens type with two 500-watt lamps and aviation red color shades, showing not less than 6 flashes per minute and having a luminous period of not less than 35 per cent. As an alternate system of marking such hazardous flying areas, certified 24-inch rotating landmark beacons equipped with 1,000 watt lamps and lamp changers and with red cover glasses and making 6 revolutions per minute may be used.

All lights marking hazardous flying areas should be exhibited from sunset to sunrise.

At the present time each radio station is being treated as a special case. The regulations outlined above are for advisory use only. In a new installation, it is now necessary to submit to the Federal Communications Commission (through Herbert L. Pettey, Secretary of the Commission), the plans for lighting and painting of radio towers. The submitted plans may be approved, or they may be returned with additional requirements which must be fulfilled.

Due to the tower obstruction lighting requirements, it is necessary to furnish up to 2 kw power for lighting the obstruction lamps. In the case of vertical radiators, these lamps are located on a structure at r-f potential, and means must be provided for isolating the lighting circuits on the tower from ground. Figures 10 and 11 indicate four methods which have been successfully used for this purpose. Use of the insulated generator as shown in Figure 10 is no longer necessary, since there are commercially available satisfactory chokes capable of isolating potentials up to 10,000 volts at broadcast frequencies.

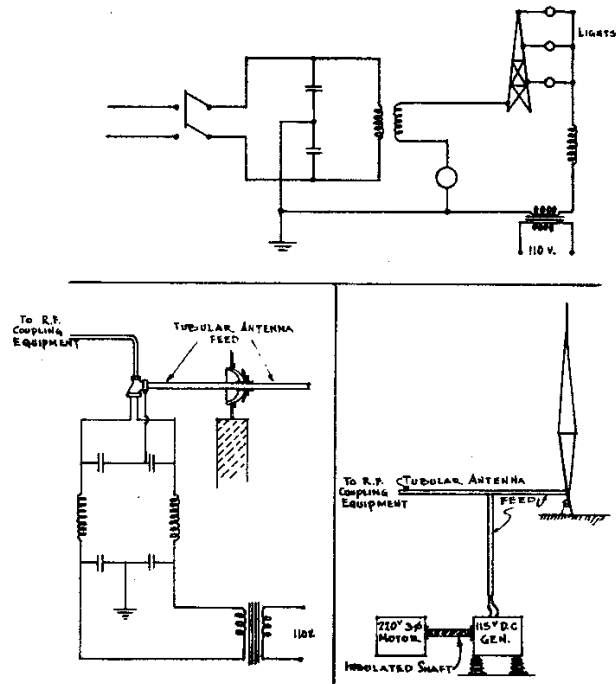

Figure 10

Three methods which have been successfully employed to transmit one or more kilowatts of lighting power to mast aircraft obstruction lights.

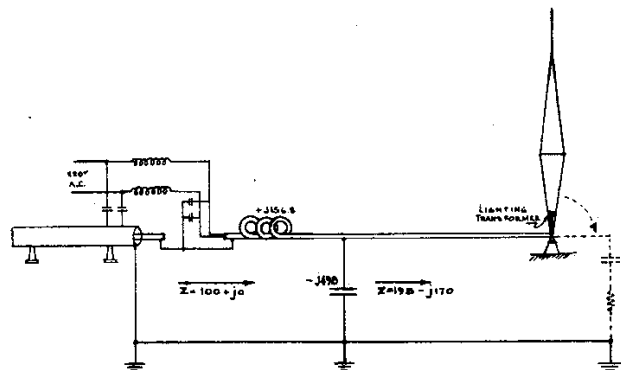

Figure 11

Method used to transmit lighting current to guyed vertical radiator at WLW. Note simplicity of method employed for coupling power from concentric transmission line to the antenna.

ANTENNA SYSTEM COSTS

Indicative of present costs of antenna systems

employing either the guyed type or self supported type of tower, are Figures 12 and 13. The costs indicated on these graphs are based on average conditions in the field. In order to allow a station engineer to more intelligently figure the costs involved in the design of a complete antenna system, the following items are listed which should be included in his estimate:

- Structural Steel
- Insulators
- Ground System
- Foundations
- Erection
- Obstruction Lighting Equipment
- Painting
- Freight
- Insurance
- Engineering Expense

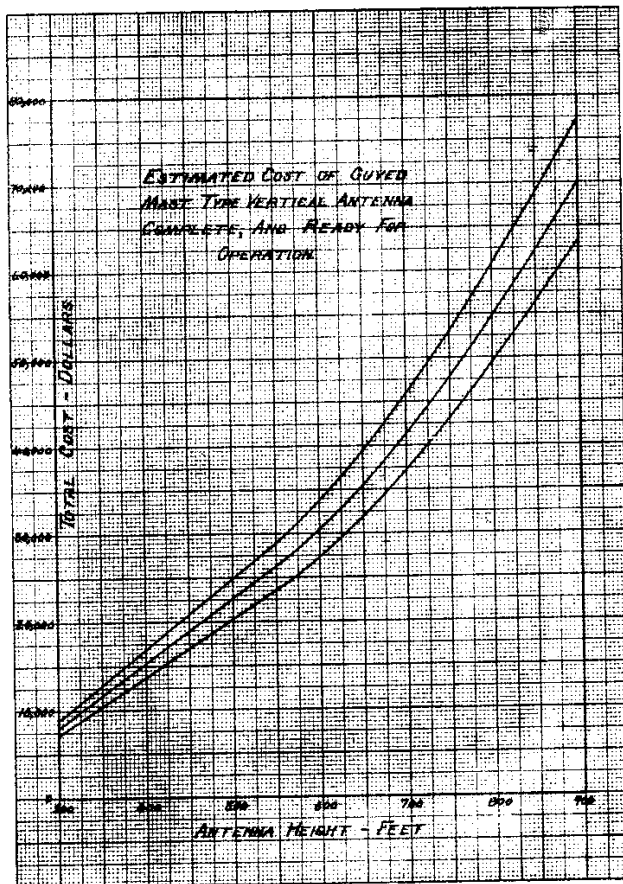

Figure 12

These items are included in the estimates shown in Figures 12 and 13. In a particular installation, one or more of the items indicated above might run considerably more than the average. This is particularly true in the cases of foundations, erection, obstruction lighting and freight.

It should be stated here that the most economical method of increasing the general efficiency of a broadcast station can usually be obtained by improving the antenna system. As an example of antenna economics, consider the following case. A 1 kw regional station desires to improve its coverage. It applies to the F.C.C. for a power increase to 2½ kw. If the application is granted, the average station incurs the following expenses:

Litigation \$ 1,500.

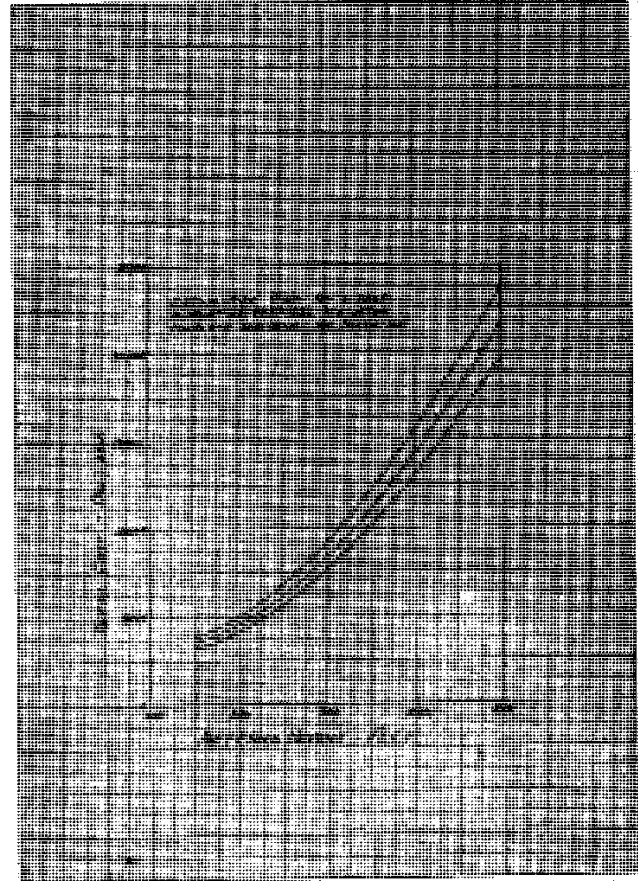

Figure 13

New Transmitting equipment complete with tubes and power supply	15,000.
Miscellaneous Modifications	1,000.
Installation of Equipment	<u>1,500.</u>
	\$19,000.

The annual operating expenses of the station will be increased by \$3,000, plus amortization and interest on the above capital expenditure. The license for the increased power probably allows only daytime operation at 2½ kw.

That is the dollars and cents story of the power increase, but what does the millivolt and listener side of the picture show? The average 1 kw regional station in this country now has a signal output of 125 mv/m at one mile. For 2.5 kw this signal is increased to 198 mv/m - a 4 db gain in signal. A similar gain in signal can be made by the installation of a .25 wave self-supporting vertical radiator, whose cost will depend on the operating frequency. The estimated complete installed cost is as follows:

1500 kc	\$ 4,200.
1000 kc	6,000.
600 kc	14,000.

The station would have saved money by purchasing a new antenna rather than higher powered transmitting equipment. A \$3,000 a year saving would have been made since no increase in operating costs would be included with the new antenna. And the signal increase would have been full time rather than part time.

This example should indicate the economic im-

portance of proper antenna design and the necessity of a careful balance of antenna cost with respect to the complete transmitting plant.

SUMMARY

1. The two-tower construction, which has been used in the past, is definitely outmoded by the single vertical radiator.
2. Use of a vertical radiator in place of an older conventional antenna will, in the average case, produce a signal increase equivalent to doubling the power of the transmitter. The exact signal gain will depend upon the efficiency of the existing antenna.
3. The self-supporting radiator may be used effectively at heights of approximately $1/2$ a wavelength. It can confidently be expected to perform with approximately the same efficiency as the guyed type of antenna.
4. If the self-supporting tower antenna is used, precautions must be taken to prevent excessive dielectric losses in the soil near the tower base. A high base capacitance, of itself, does not contribute to low efficiency.
5. The ground system should be radial in nature and should consist of maximum amount of copper extending to the maximum radius consistent with economical considerations. In practice, this should mean a radius of at least $1/2$ wavelength and a number of radials at least equal to 120.
6. To increase the non-fading area of a transmitter as much as possible, is an important factor of design which is not yet completely solved. There have been a number of studies which indicate that the optimum height, from the fading viewpoint, ranges between .45 and .60 of a physical wavelength with the types of structures so far placed in service. The exact height cannot be determined until further work has been completed.
7. The vertical radiator is especially well adapted to use in directive antenna systems. Published theoretical methods of pattern calculation agree with field results. However, the efficiency of directive antennas has not yet been reduced to a mathematical process, and its determination must be based upon the engineer's experience.

-
1. Stuart Ballantine, Proceedings of I.R.E., Vol. 22, P. 624, (1934).
 2. J.A. Stratton and H.A. Chinn, Proceedings of I.R.E., Vol. 20, P. 1892 (1932).
 3. A. Sommerfield, Ann. D. Phys., Vol. 28, P. 665 (1909).
 4. F. Eppen and A. Gothe, Electricische Nachrichten Technik, Vol. 4, P. 176, (1933).
 5. O. Bohm, Telefunken-Ztg., No. 57, P. 30, 31 (1931).
 6. Reference 1, P. 626.
 7. Seventh Annual Report of the Federal Radio Commission 1933, P. 24.
 8. LaPorte - Electronics, August 1934, P. 241.
 9. H.E. Hallburg, Proceedings of Radio Club of America, February, (1931).
 10. Stuart Ballantine, Proceedings of I.R.E., Vol. 12, December (1924).
 11. P.P. Eckersley, Proceedings of I.R.E., Vol. 18, P. 1160, July (1930).
 12. U.S. Patent 1,897,373.
 13. J.H. DeWitt, Jr., Jour. Tenn. Acad. Science, Vol. 8, P. 95, (1932).
 14. WLW, WSM.
 15. G.L. Davies and W.H. Orton, Bureau of Standards Research Paper No. 435, (1932).
 16. G.C. Southworth, Proceedings of I.R.E., Vol. 18, P. 1502 (1930).
-

Annual Meeting

As announced, the 25th Annual Meeting was held at Columbia University on the night of December 3. The purpose of the annual meeting in the general discussion of the business affairs of the Club and, more specifically, preparation of nominations for the several offices as well as for the directorate of the Club. This meeting was, as is all too usual, only meagerly attended, although it was characterized by an extremely open and frank discussion of the potential nominees whose names were offered. As a result of the extended discussion and the subsequent balloting, the roster of nominees as given below was determined upon:

For President: Harry W. Houck
Ralph J. Langley

For Vice President: F.X. Rettenmeyer

For Treasurer: Joseph Stantley

For Recording Secretary: Keith Henney

For Corresponding Secretary:
Fred Klingenschmitt

For Members of the Board of Directors:

E.H. Armstrong	H.M. Lewis
G.E. Burghard	R.H. McMann
A.B. Chamberlain	John Miller
C.L. Farrand	Fred Muller
L.C.F. Horle	L.W. Rosenthal
Frank King	C.R. Runyon
W.A. Winterbottom	

In connection with the nomination of candidates for office in the Club, the attention of the membership is called to the following excerpt from Article 7, Section 1, of the Constitution of the Club:

"Members unable to attend in person the Annual Meeting at which the above nominations are called for may obtain from the Corresponding Secretary a prescribed blank form on which they may nominate candidates for any or all of the above offices. Such nominations must be in the possession of the Corresponding Secretary within ten days after the Annual Meeting at which nominations were called for. Nominations made in this way must be three in number for any nominee to have him considered as such provided he has not already been nominated at the prescribed meeting."

Mr. Houck Withdraws

The Editor of the PROCEEDINGS is in receipt of the following letter from President Houck:

December 6, 1934.

Editor Proc. of the Radio Club of America,
90 West Street,
New York, New York.

Dear Sir:

I shall be grateful if you will find space in the forthcoming issue of the PROCEEDINGS of the Radio Club of America for this work of explanation for the withdrawal of my name from the roster of nominees for election to office in the Club.

Let me say first that I am thoroughly appreciative of the compliment which the Club pays me in nominating me for a second term as President, and I can assure the Club that my interest and active participation in the affairs of the Club will continue, to whatever extent I may be called upon to assist.

I feel, however, that in view of Mr. Langley's nomination for the presidency, and the good effect upon the management of the Club by the precedent of single term presidency of the Club, set by Mr. Sadenwater in 1931, and followed by all of the Club presidents since that time, that I can best serve the Club by this action.

I, therefore, addressed the Secretary, asking that my name be withdrawn, and I urge that all possible support be given to Mr. Langley in the coming election.

Respectfully yours,

Harry W. Houck